

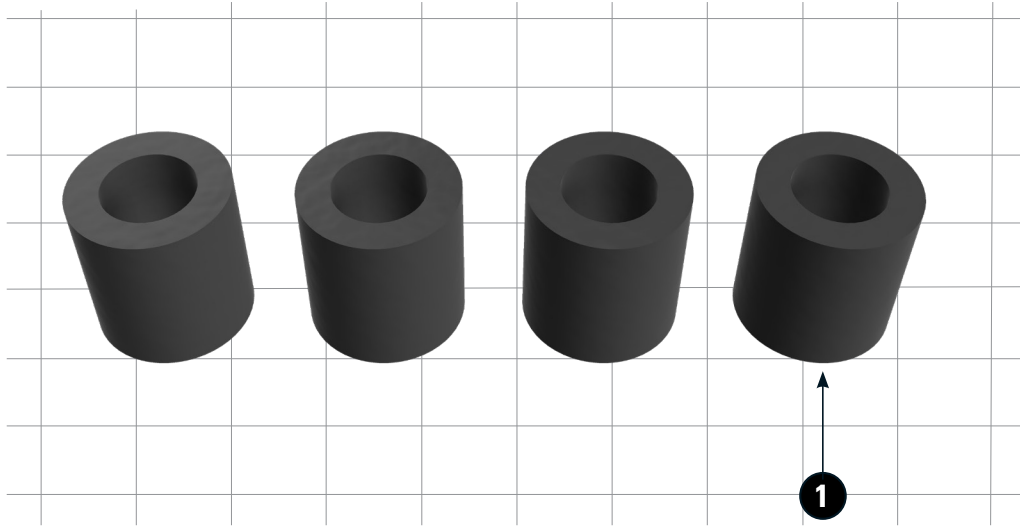







FIXIERKIT BEIFAHRERSITZBANK

Passenger seat fixing kit | Kit de fixation pour siège passager | Kit de fijación del asiento del pasajero | Kit fissaggio sella passeggero

Art.-Nr: **13106-000**



LEGENDE/KEY/FILE LÉGENDE

-  **Anbau Tipp**
Fitting tip
Astuce de montage
-  **Achtung**
Attention
Attention
-  **Vergrößerung**
Magnification
Grossissement
-  **Montagepaste**
Fitting lubricant
Lubrifiant de montage
-  **Schraube**
Screw
Vis
-  **Schraubensicherung**
Thread locking fluid
Freiniflets
-  **Drehmoment**
Torque
Torque
-  **Reiniger**
Cleaner
Nettoyant



#	Bauteil component composant	DE Die Farben der Abbildungen dienen nur der Veranschaulichung. EN The colors are for illustrating purposes only. FR Les couleurs utilisées sont à titre indicatif seulement.	DIN	ISO	Menge quantity quantité
1	Hülse / Sleeve	ØD 22 - Ød 12,8 - h 20mm			4



